

Assembly Tutorial: Intel D210GLY2A + Noah3988B80 enclosure

The following components have been used:

- Noah 3988B80 enclosure with integrated PSU
- Intel D210GLY2A
- Slim-Line DVD-ROM
- Slim-to-IDE adapter
- 3,5" SATA HDD + SATA cable
- SATA power adapter
- 1024MB DDR2 memory



At the beginning, the cover of the enclosure gets removed:

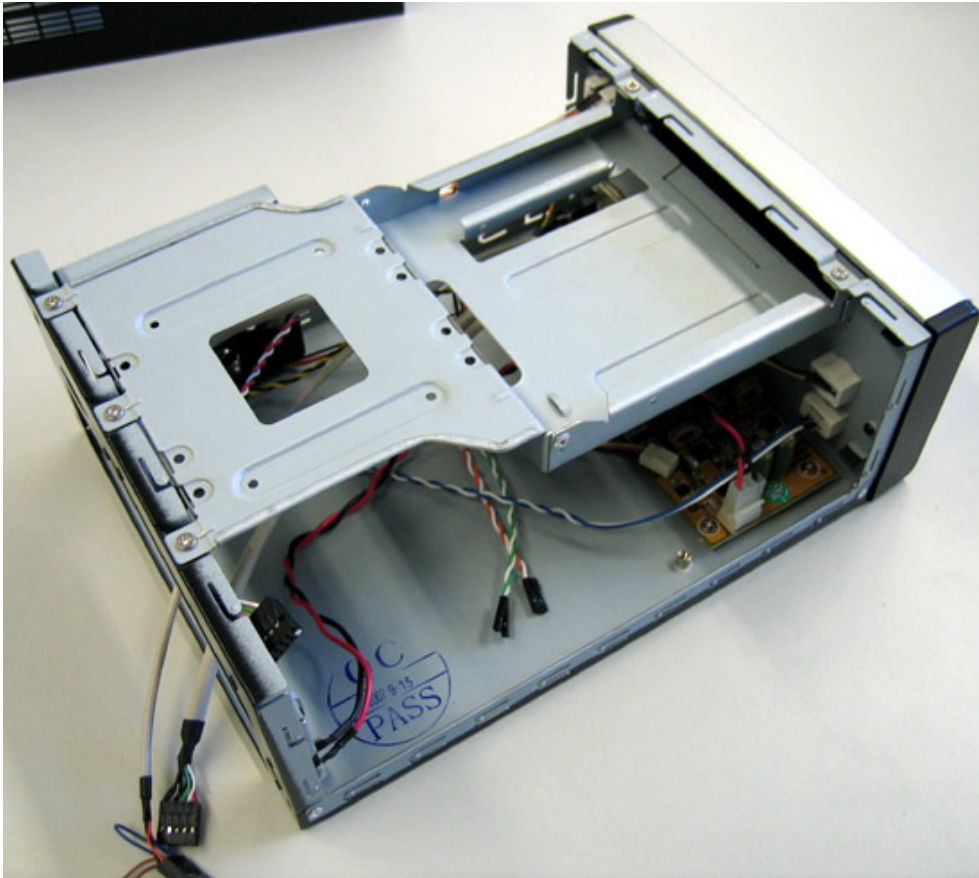

The mounting unit for HDD and DVD-drive gets removed, too:

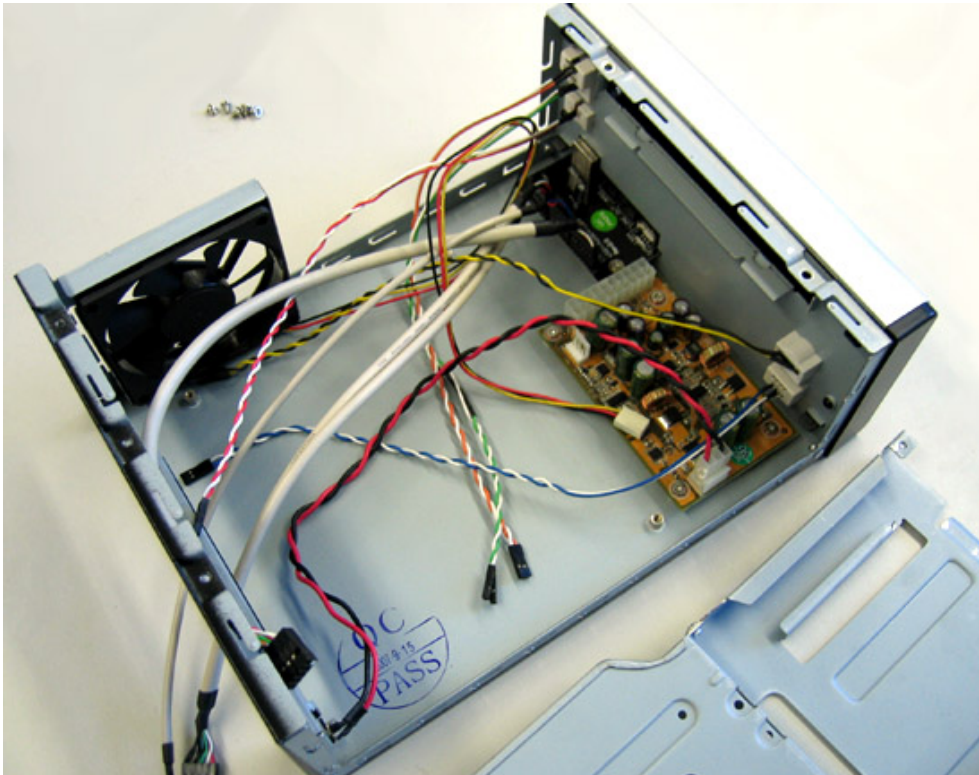

The backpanel gets plugged into its place:



CARTFT.COM
Shop for mobile
PC- and GPS-Solutions

Power Up Your Car

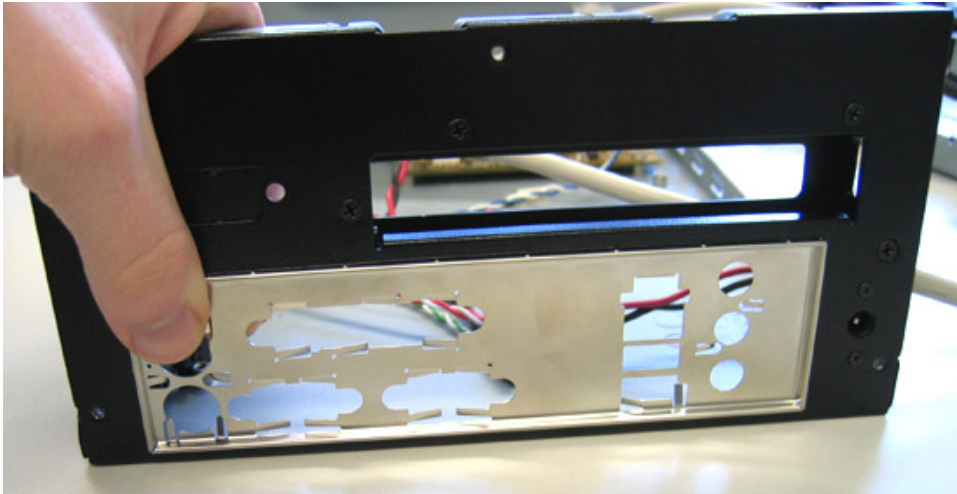

The motherboard gets installed and screwed tight:

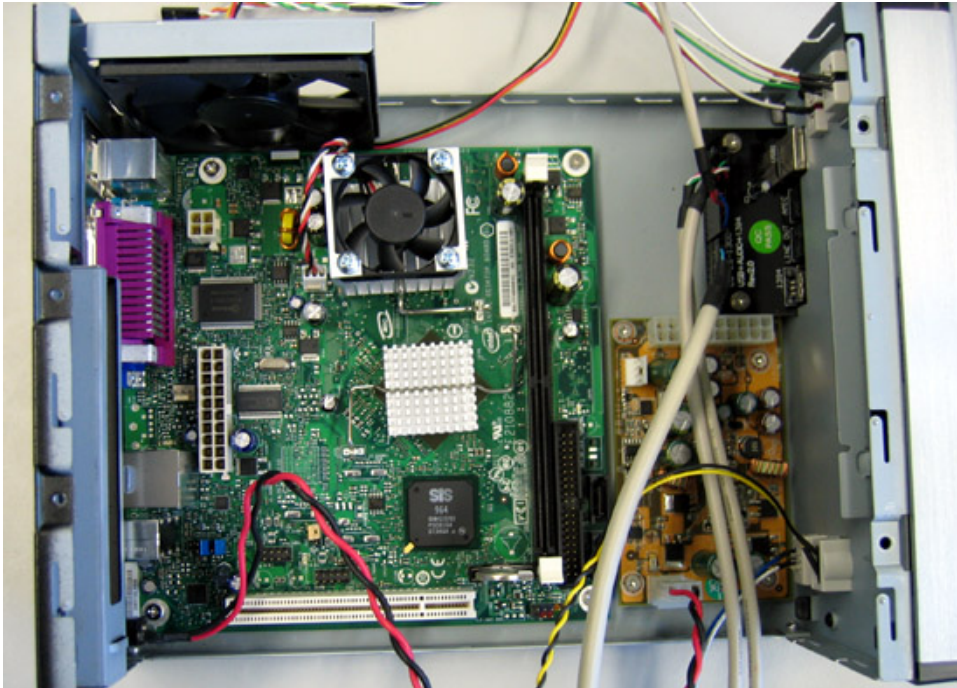

The DDR2 memory gets installed:

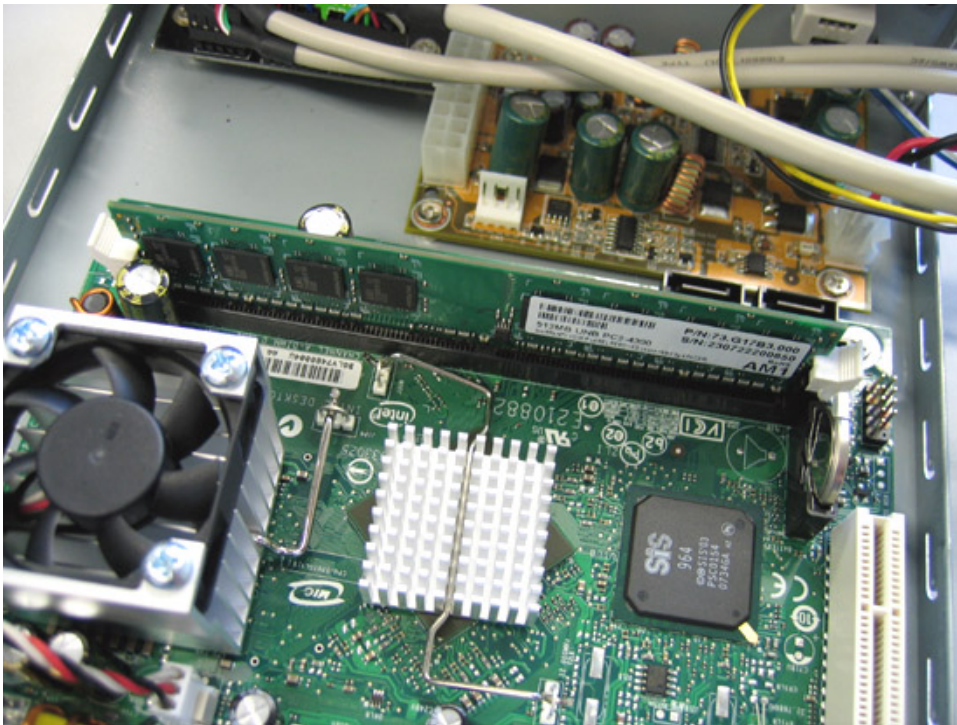

The ATX cable and the P4 connector (!) get plugged in:

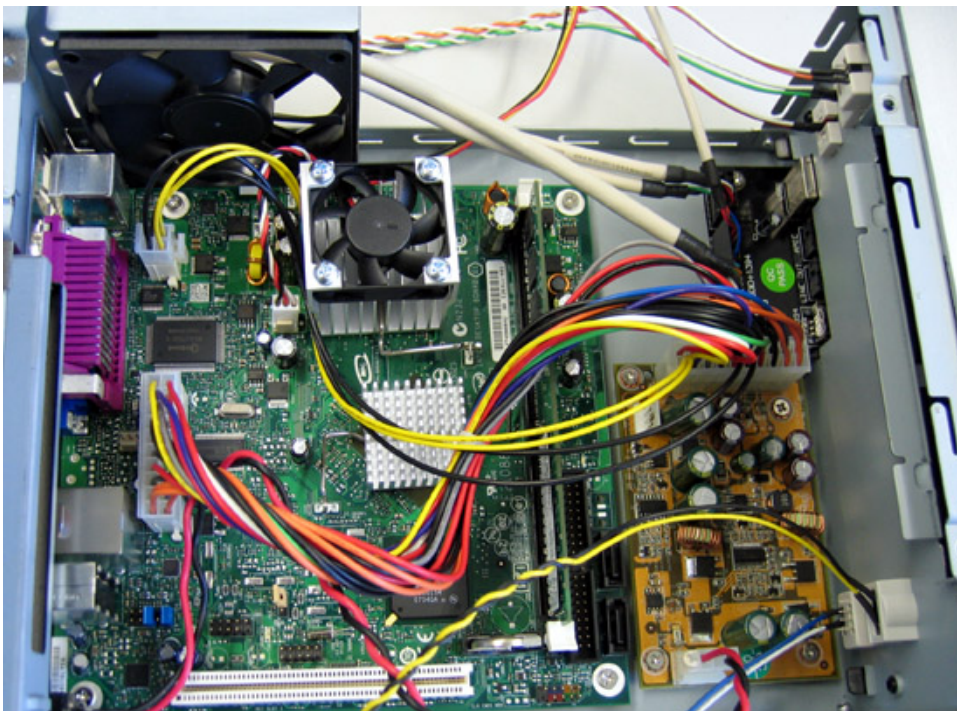

The system fan gets plugged behind the ATX socket:

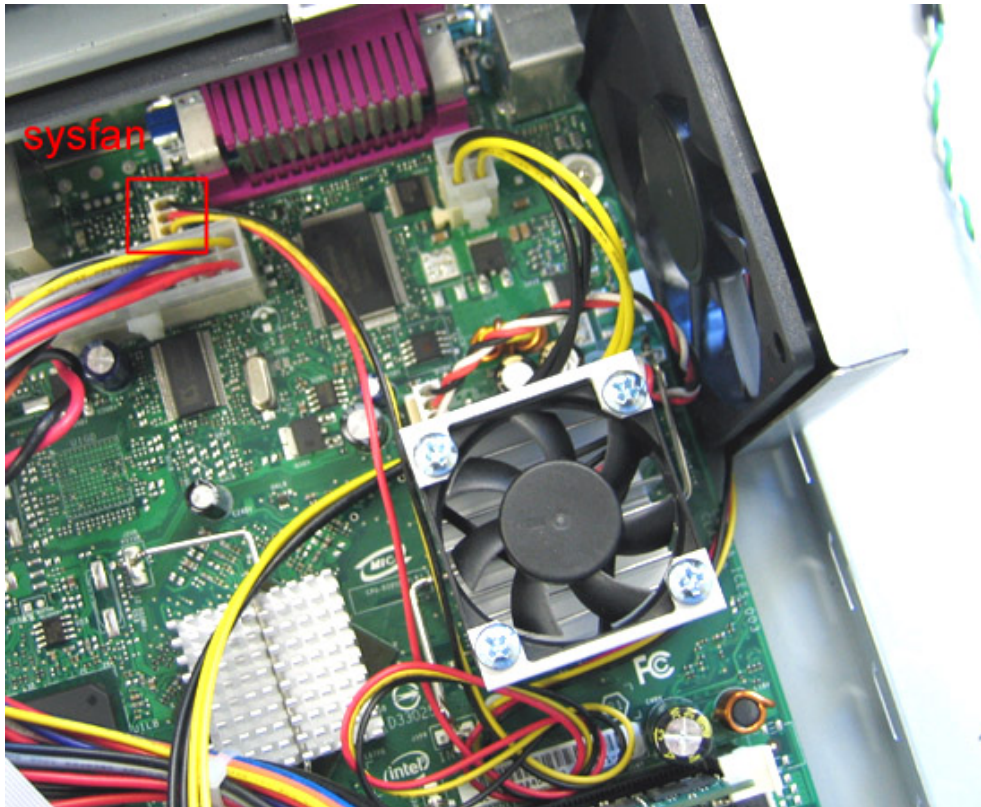

The frontpanel connection:

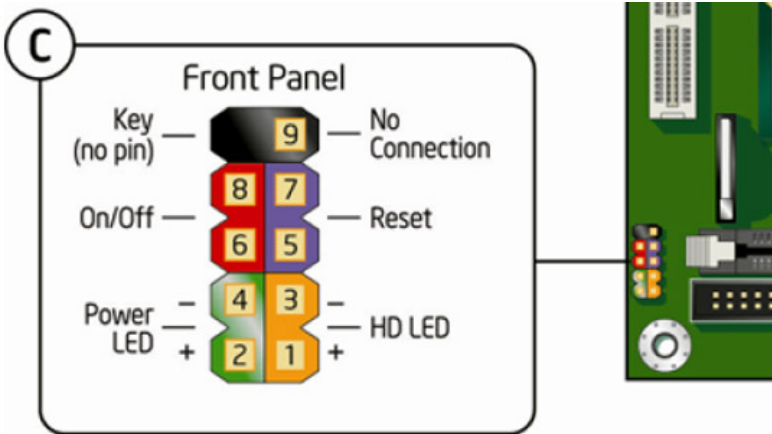

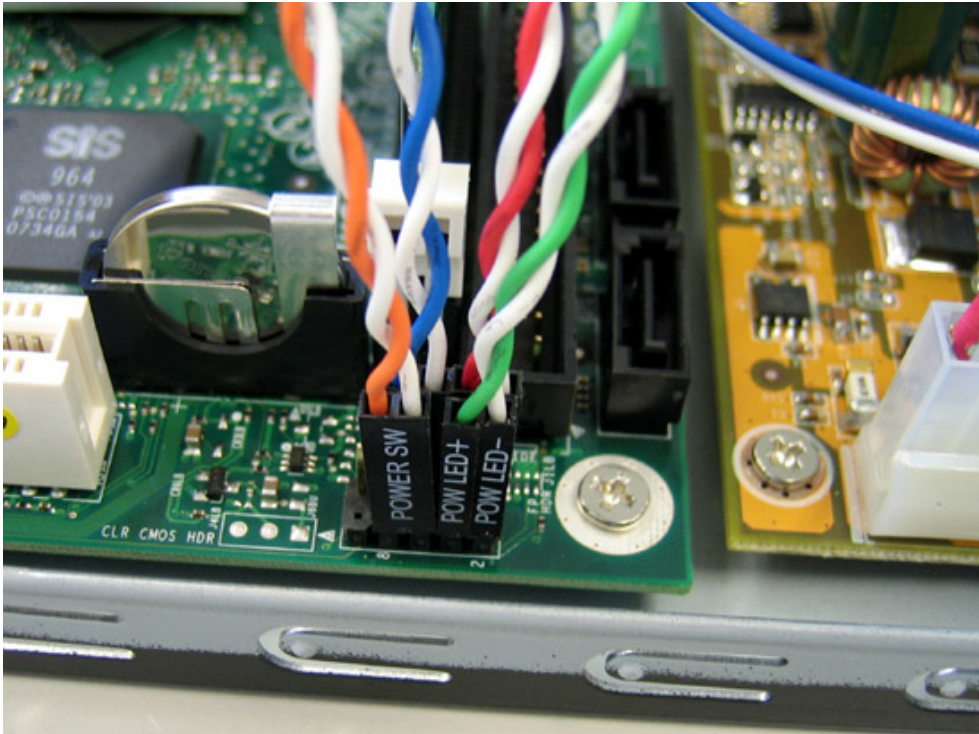

The power cable with the Molex connectors gets plugged onto the power supply separately:

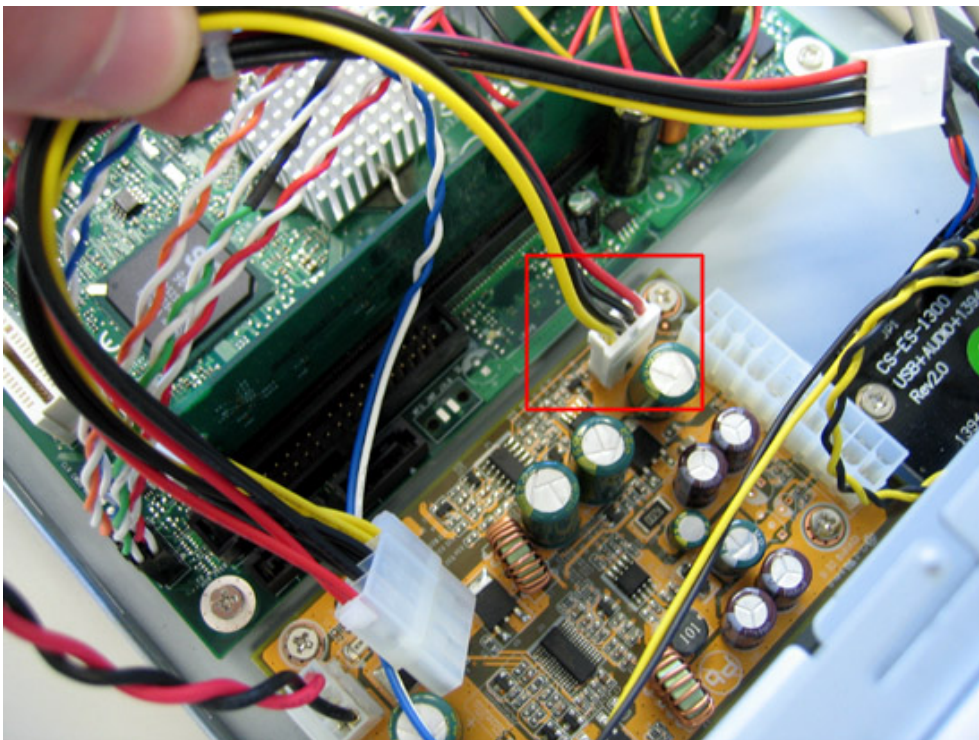

USB and AUDIO connection:

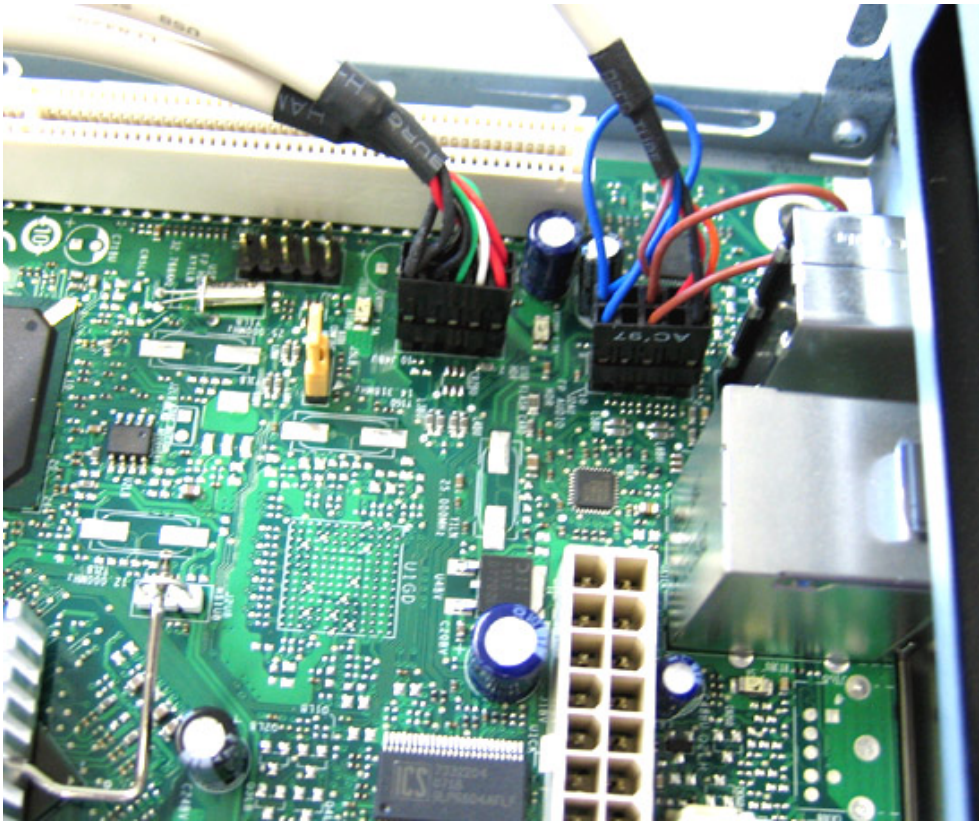

The Slim-to-IDE adapter gets screwed at the slim-line drive and gets pushed into the mounting unit:

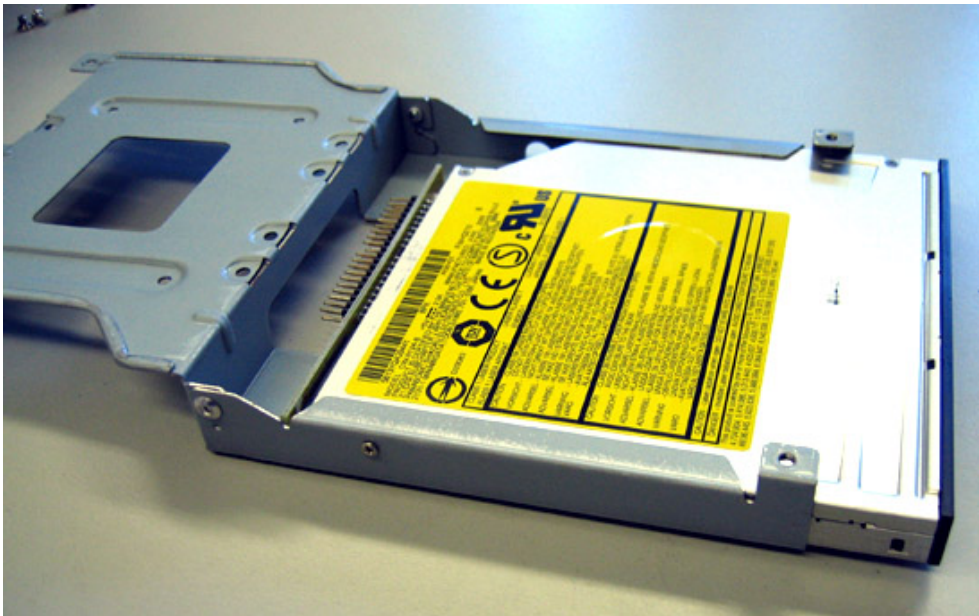

The HDD gets installed with 3 screws:



CARTFT.COM
Shop for mobile
PC- and GPS-Solutions

Power Up Your Car



The front of the enclosure gets removed...



... so the slide-in for the slim-line drive can be made free:



CARTFT.COM

Shop for mobile
PC- and GPS-Solutions

Power Up Your Car

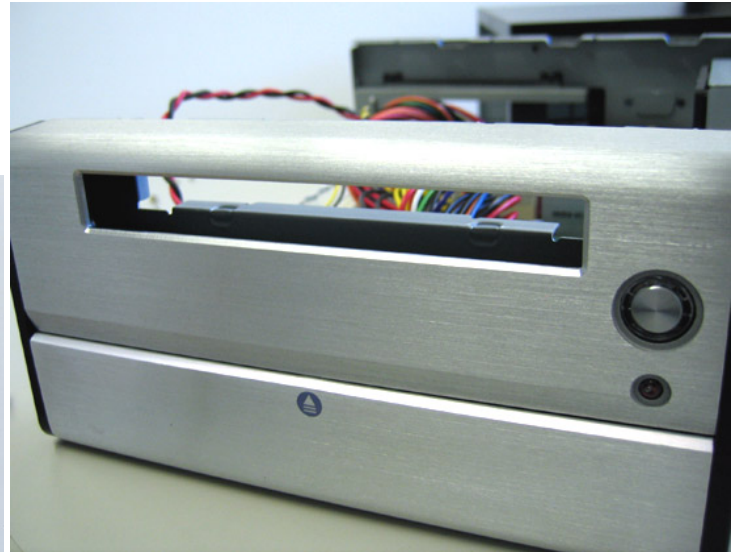
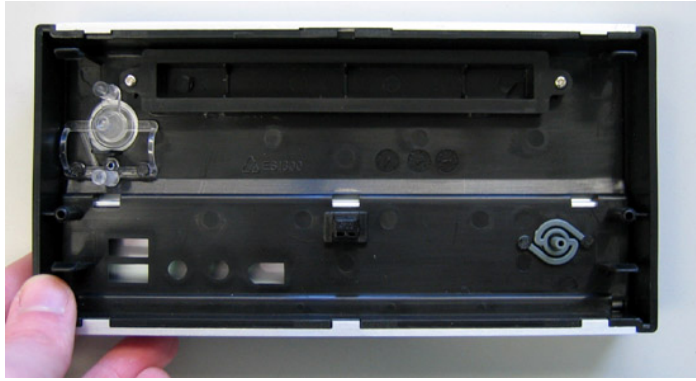

The SATA power adapter gets connected to the additional Molex-connector cable and to the HDD. The SATA cable gets connected to the HDD also.

The IDE cable and the necessary power cable get connected to the slim-to-IDE adapter.

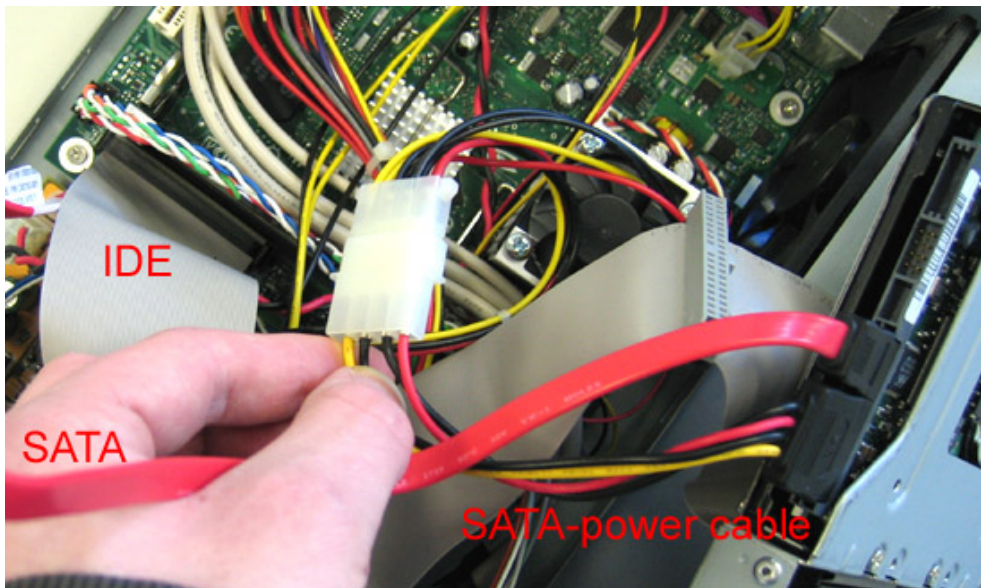

All the cables are then laid or packed well into the enclosure. The mounting unit gets insert into the enclosure and gets screwed tight:



CARTFT.COM
Shop for mobile
PC- and GPS-Solutions

Power Up Your Car



Finally the cover of the enclosure gets screwed again – Finished!



PicoPSU120:

The system can also be run with a picoPSU120. Eventually the whole for the power jack has to be made bigger, as shown in the picture below.

Note: Case-modification voids the warranty!

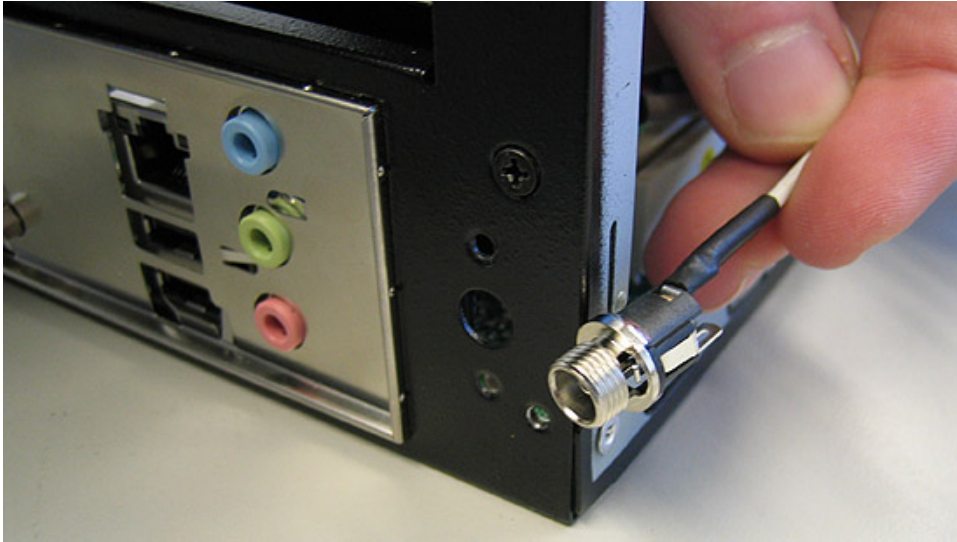

Otherwise the picoPSU120 gets connected with the adapter cables as described above.

Author: B. Lambert - CarTFT.com
Last update: 2008-02-14